

Art. Nr. 406100

1/11

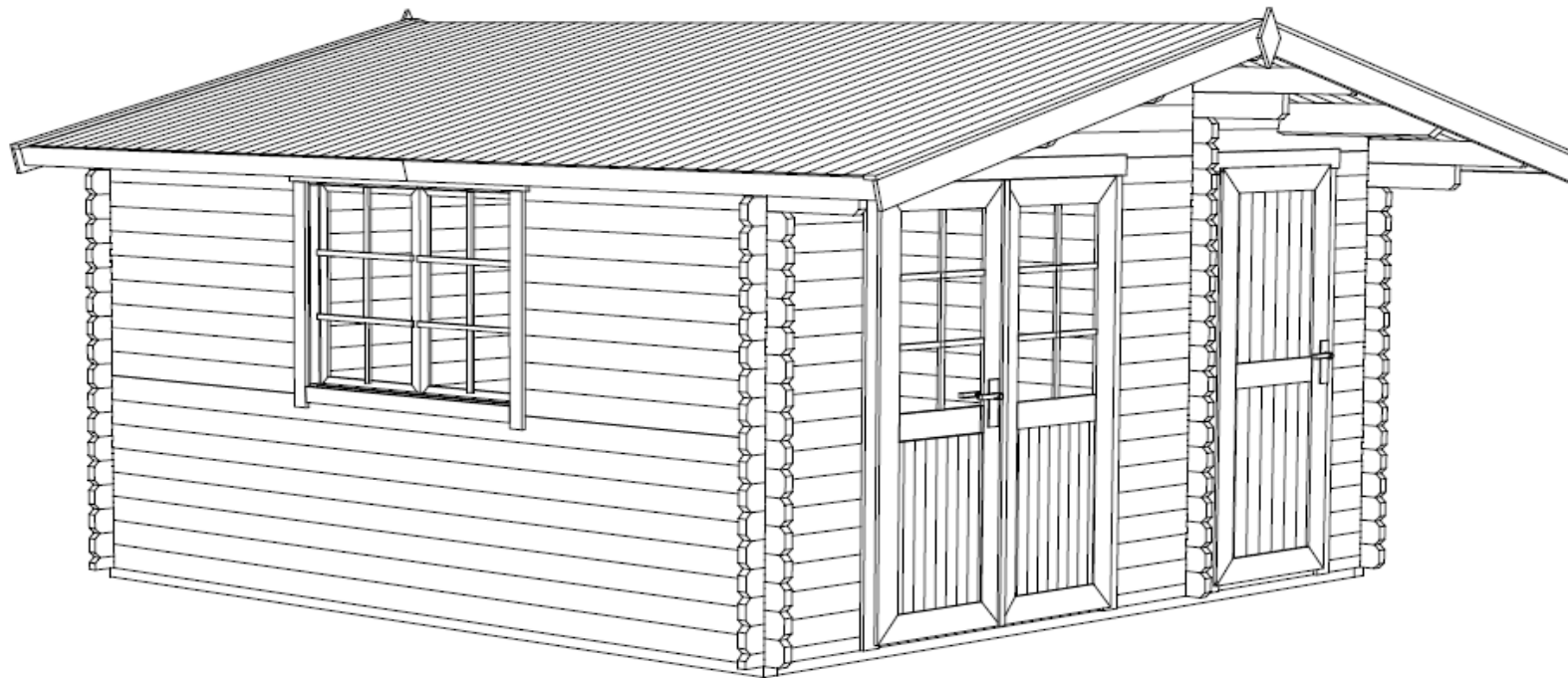

40x114

7.12.2012

FOUNDATION - FUNDAMENT - FONDATION

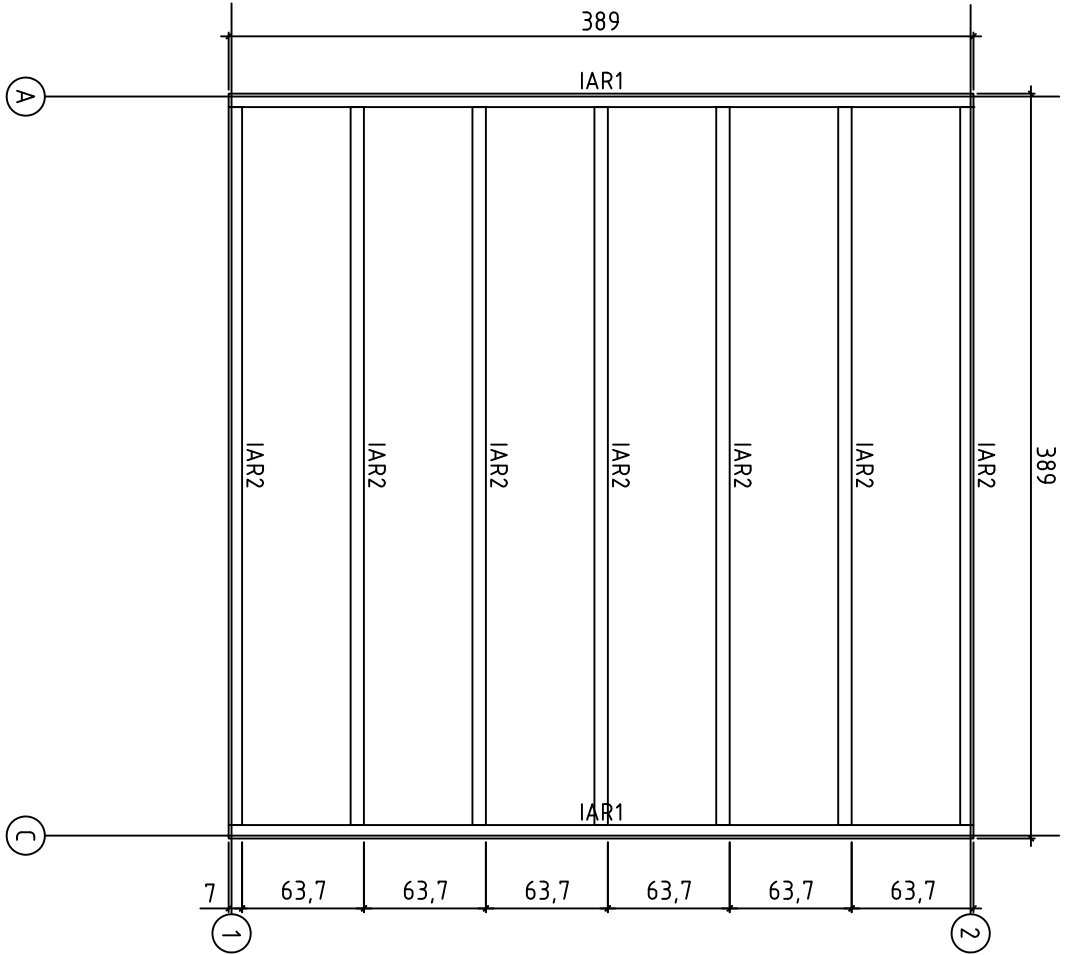

FLOOR BOARDS - FUSSBODENBRETTER - PLAN POSE PLANCHER

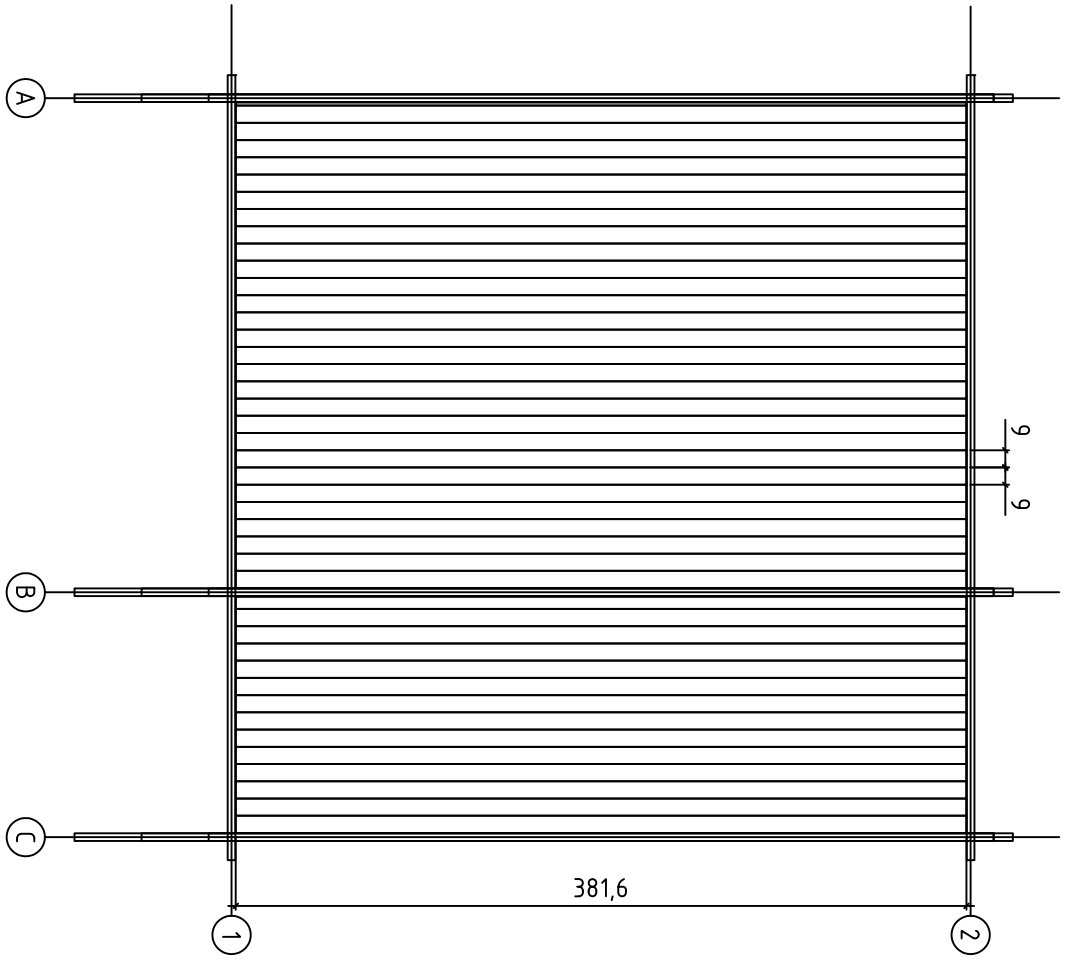

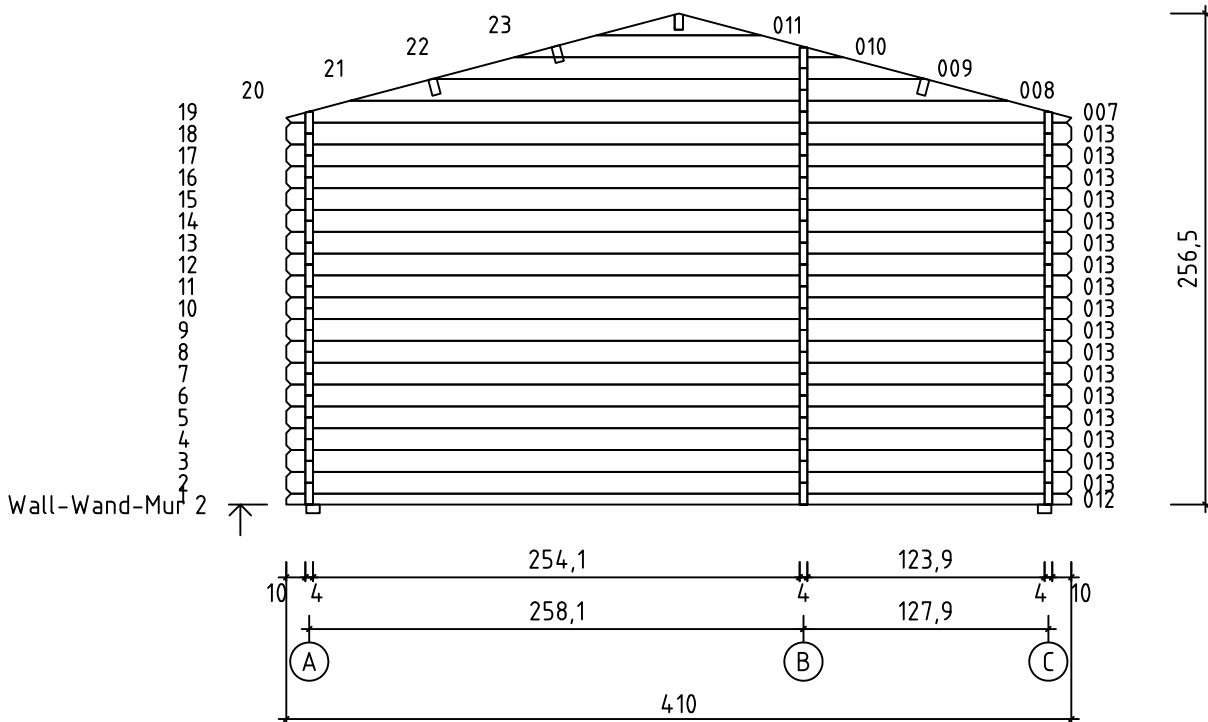
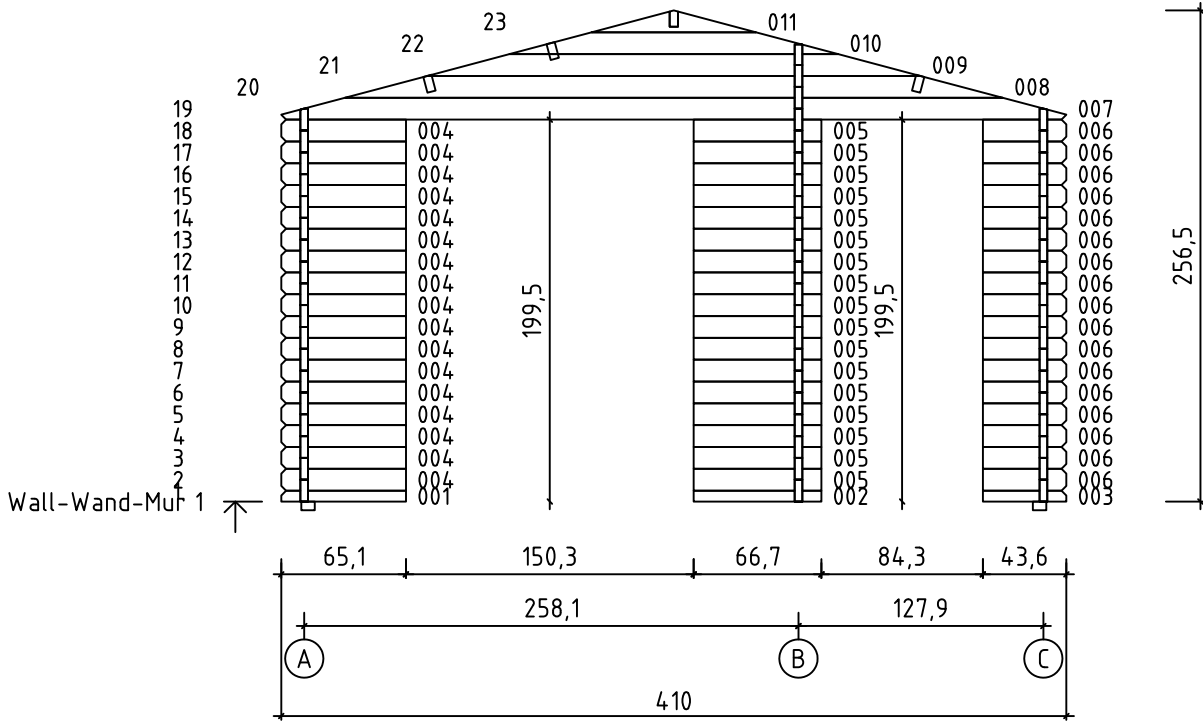

Art.Nr. 406100
490

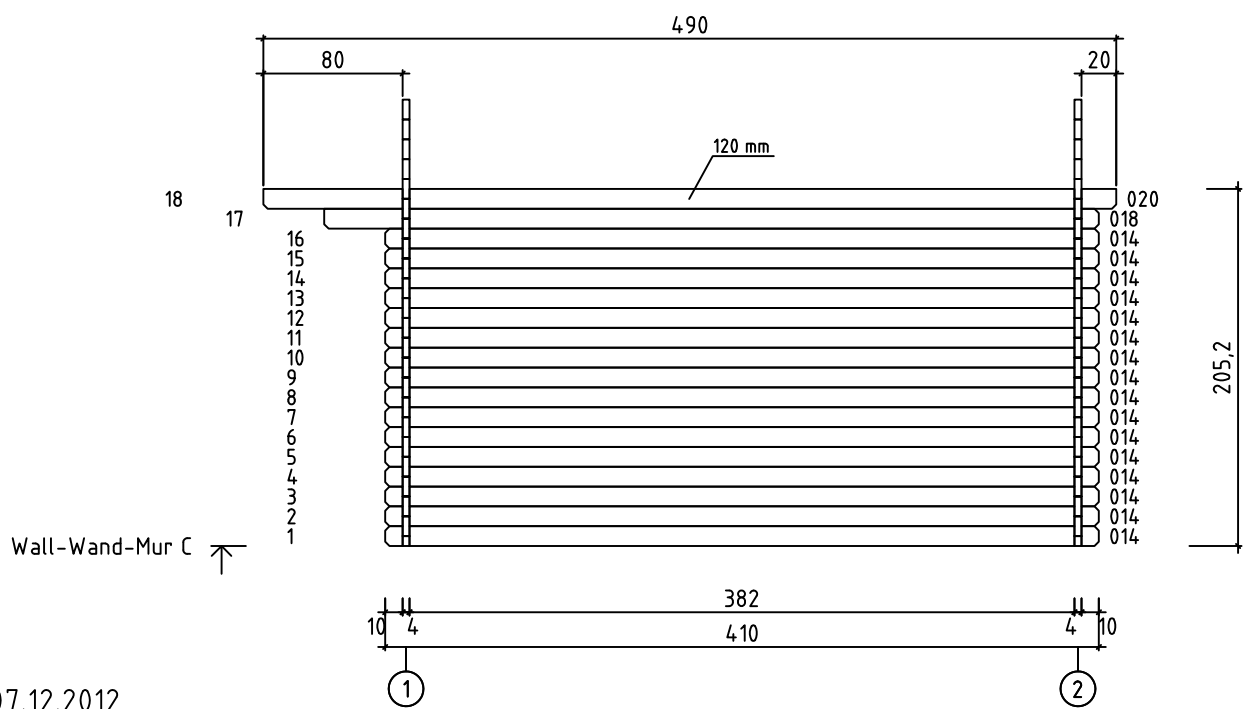
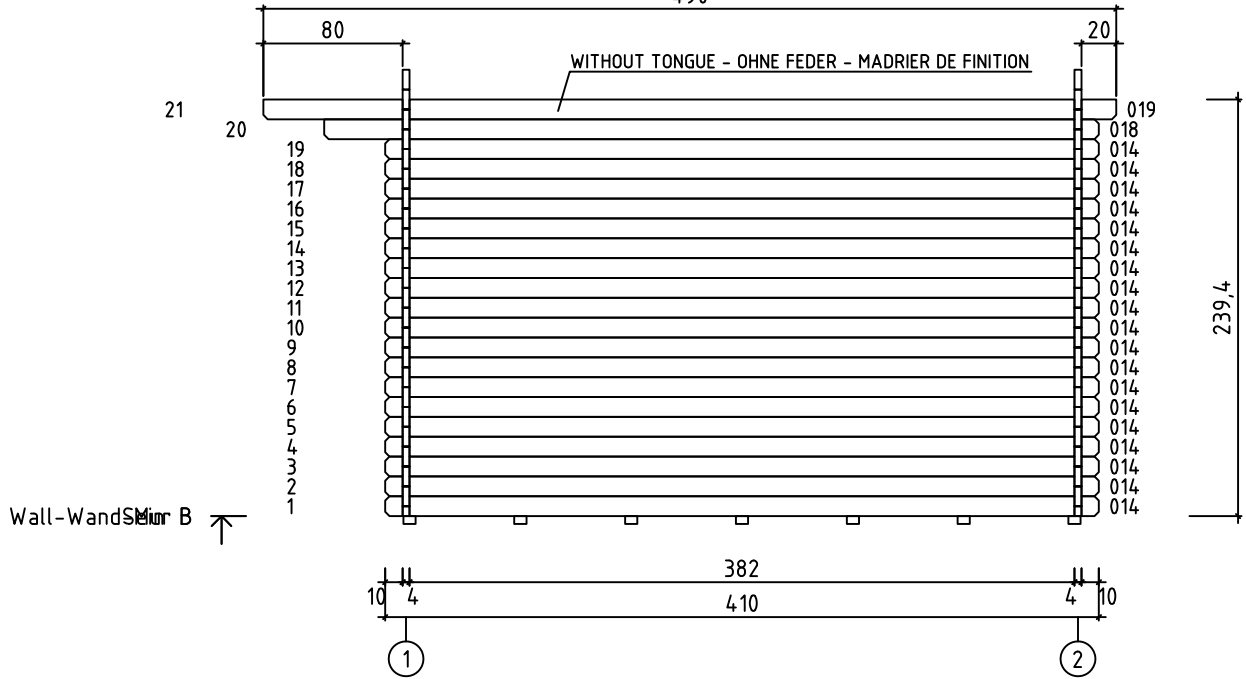
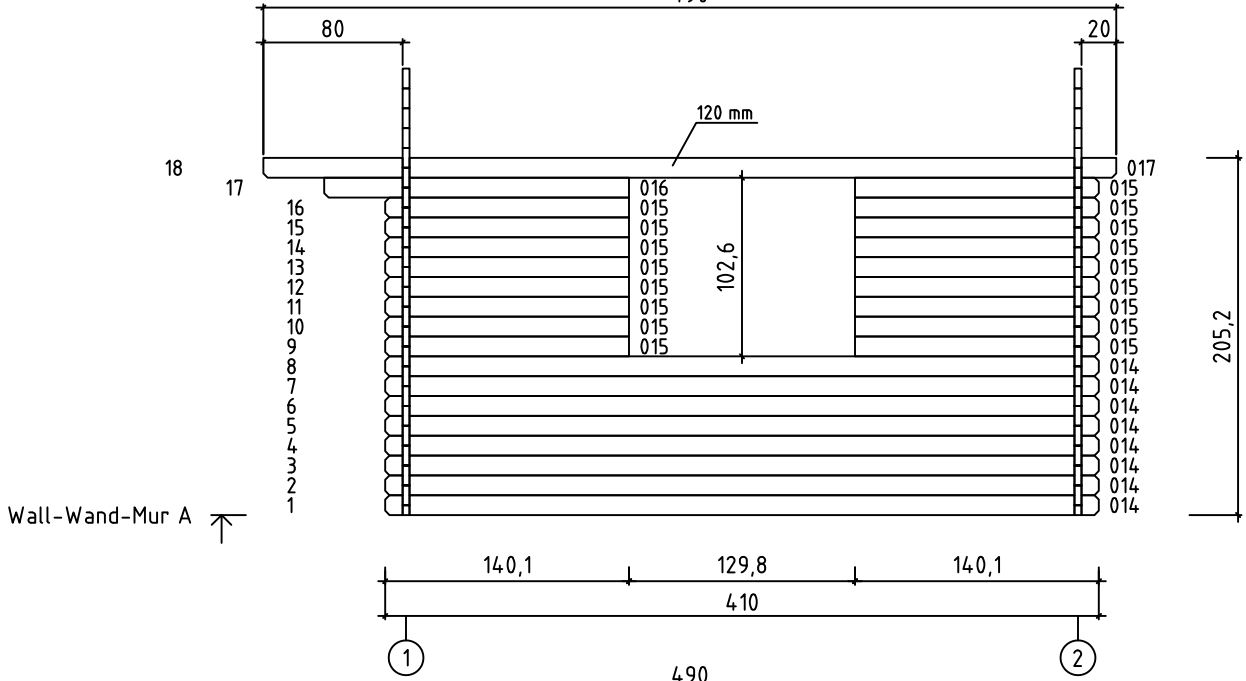

Art.Nr. 406100

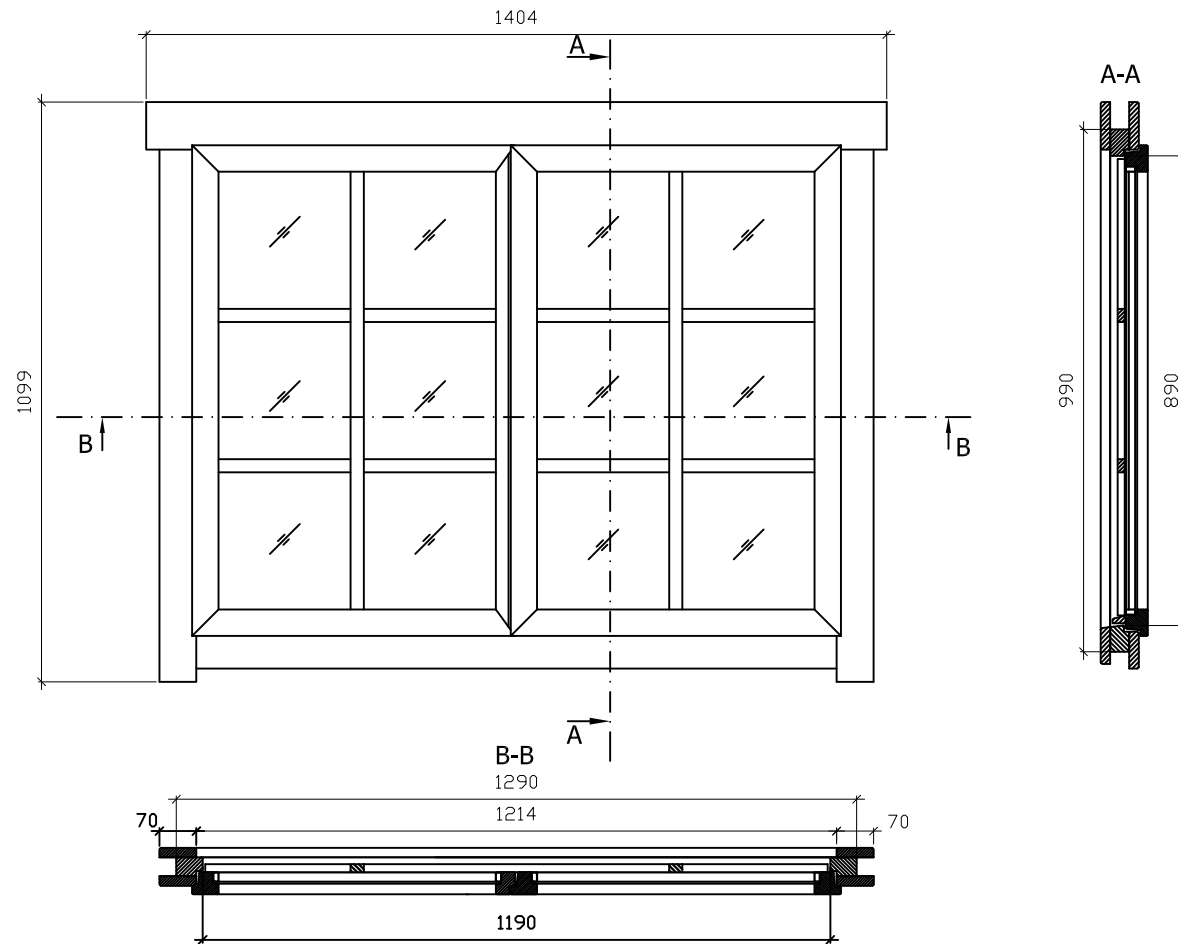

Glass size - Glasgröße - Taille de la vitre:
542x846 mm

Art.Nr. 406100

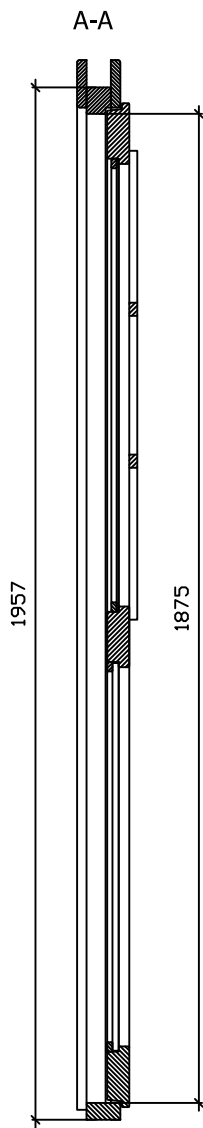
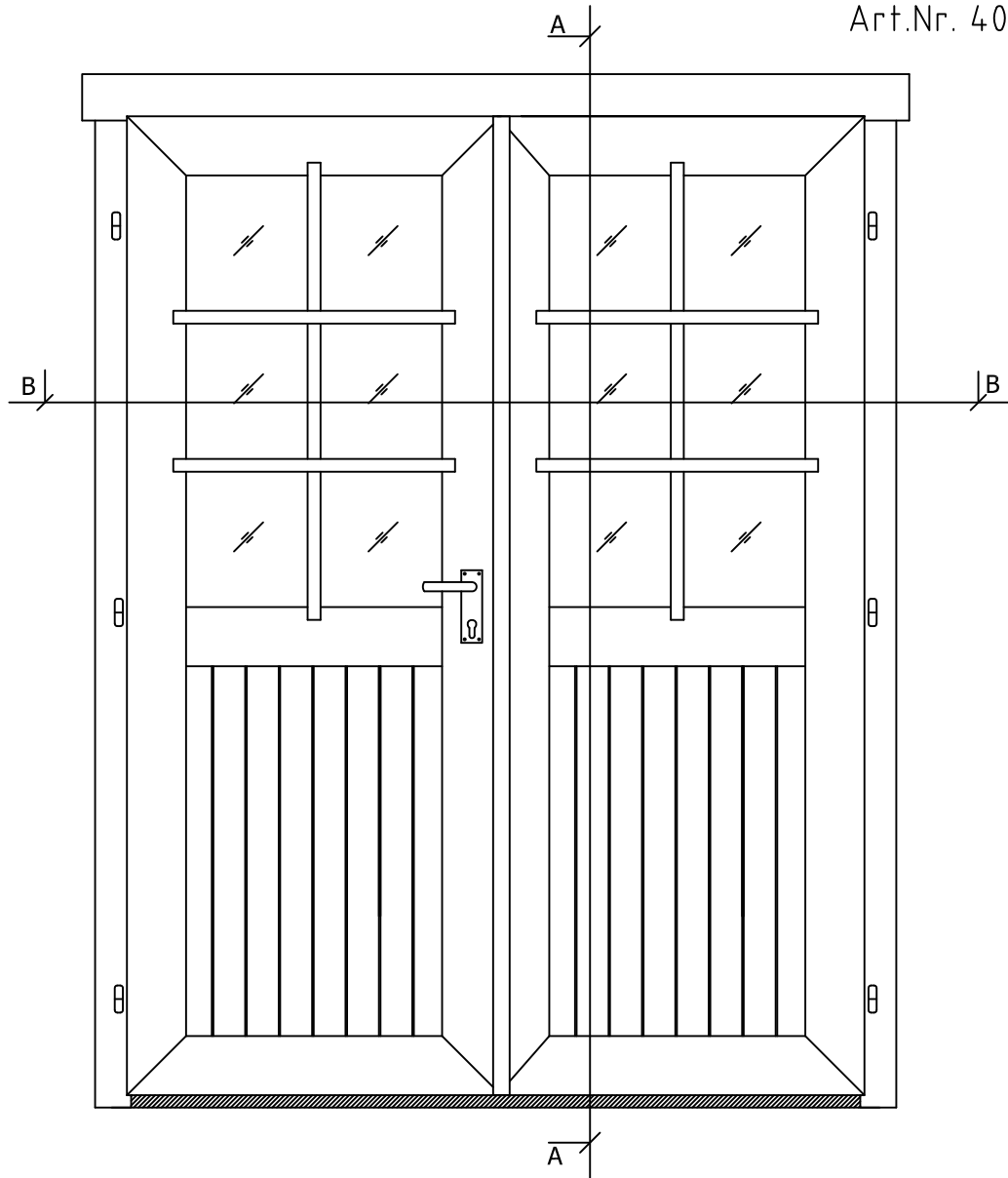



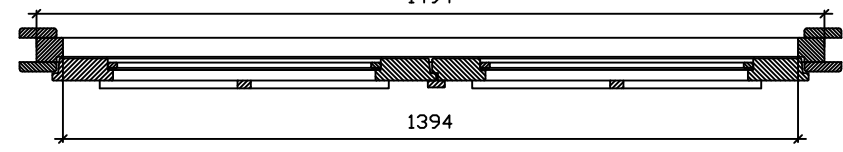





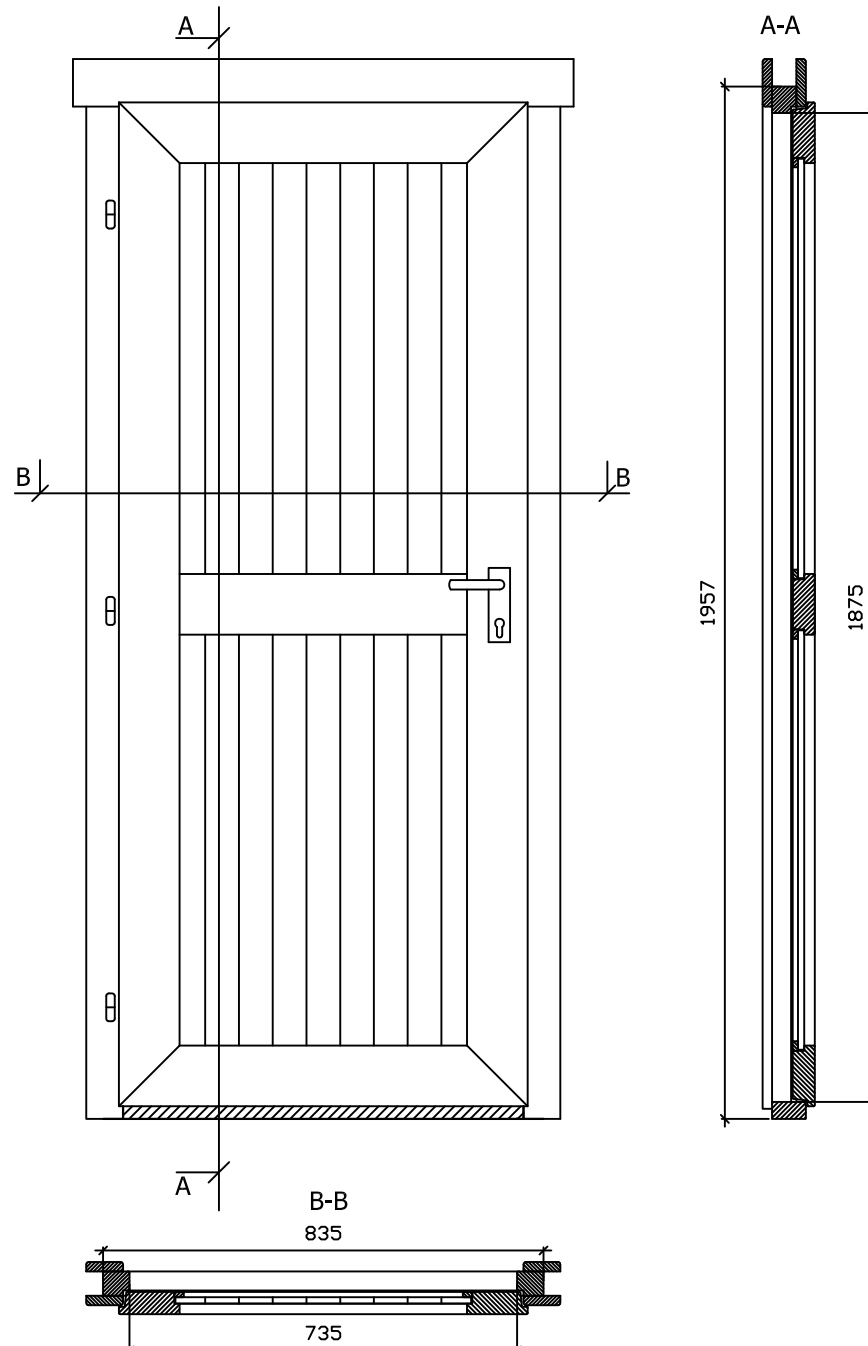

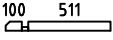
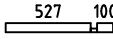

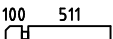
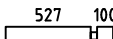
B-B
1494

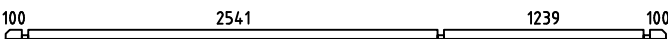
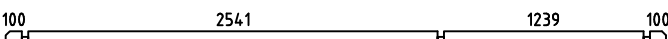
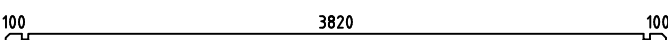
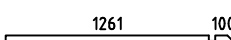
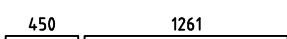

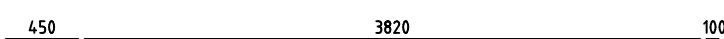

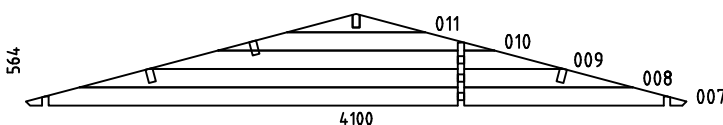



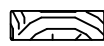

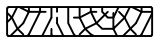

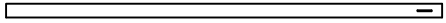



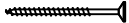
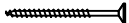
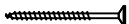





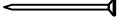
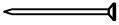
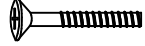
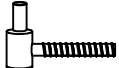

Door glass size - Glasgröße - Taille de la vitre:
514x855 mm

Art.Nr. 406100

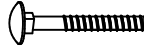

Pos	07.12.2012	Piecelist - Stücklist - Liste des composants Art.Nr. 406100	9/11	Q.	P. (mm)	L. (mm)
001				1	40x57	651
002				1	40x57	667
003				1	40x57	436
004				17	40x114	651
005				17	40x114	667
006				17	40x114	436
012				1	40x57	4100
013				17	40x114	4100
014				43	40x114	4100
015				17	40x114	1401
016				1	40x114	1751
017				1	40x114	4900
018				2	40x114	4450
019				1	40x107	4900
020				1	40x114	4900
W1-1 W2-1				2		
IAR1	FOUNDATION - FUNDAMENT - FONDATION			2	70x45	3890
IAR2	FOUNDATION - FUNDAMENT - FONDATION			7	70x45	3750
PR1	ROOF BEAM - DACHBALKEN - PANNE DE TOIT			1	44x140	4900
A-PR1	ROOF BEAM - DACHBALKEN - PANNE DE TOIT - ?????			3	44x140	4900
	FLOOR BOARDS - FUSSBODENBRETTER - LAME DE PLANCHER			43	90x18	3816
	ROOF BOARDS - DACHBRETTER - VOLIGES			110	90x18	2300
	FLOOR FILLET-FUSSBODENLEISTE - CORNIERE DE FINITION DU PLANCHER				18x18	22.81
	ROOFING FELT FILLET - DACHPAPPENLEISTE - BAGUETTE DE FIXATION DU FEUTRE BITUMEUX			4	18x58	2350

Pos	07.12.2012	Piecelist - Stücklist - Liste des composants Art.Nr. 406100	10/11	Q.	P. (mm)	L. (mm)
		EAVES BOARD - TRAUFBRETT - BANDEAU DE TOIT		4	18x90	2450
		ROOF EDGE REINFORCEMENT - DACHRANDVERSTÄRKUNG - - CORNIERE DE RENFORT DE BORD DE TOIT		4	28x34	2450
		STORM PROTECTION - STURMLEISTE - - LATTE ANTI-TEMPETE		4	22x45	2000
		GABLE MOULDING - GIEBELLEISTE - - PLANCHE DE RIVE		4	18x120	2350
		WINDOW HANDLE FITTINGS-FENSTERGRIFF - POIGNÉE D'OUVERTURE DE FENETRE		1		
		ZN NAIL FOR FLOOR FILLET - ZN NÄGEL FÜR FUSSBODENLEISTE - - POINTE POUR CORNIERE DE FINITION DU PLANCHER		46	1.4x40	
		SCREW FOR GABLE MOULDING - SCHRAUBEN FÜR GIEBELLEISTE - - VIS DE FIXATION POUR PLANCHE DE RIVE		4	3.5x35	
		SCREW FOR GABLE - SCHRAUBEN FÜR GIEBEL - - VIS POUR FIXATION DES PIGNONS		20	5x120	
		SCREW FOR ROOF BEAMS - SCHRAUBEN FÜR DACHBALKEN - - VIS POUR PANNE DE TOIT		14	5x120	
		SCREW FOR 1. WALL BEAM - SCHRAUBE FÜR 1. BOHLENREIHE - - VIS DE FIXATION DES FONDATIONS		8	5x90	
		SCREW FOR DOOR JAMB - SCHRAUBE FÜR TÜRRAHMEN - - VIS DE FIXATION POUR MONTANT DE PORTE		4	5x90	
		SCREW FOR DOOR FILLET - SCHRAUBE ZUR BEFESTIGUNG TÜRLEISTE - - VIS D'ASSEMBLAGE DU CADRE DE PORTE		5	3x30	
		SCREW FOR EAVES BOARDS - SCHRAUBEN FÜR TRAUFBRETT - - VIS DE FIXATION POUR BANDEAU DE TOIT		24	4x40	
		SCREW FOR FUNDAMENT - SCHRAUBEN ZUR BEFESTIGUNG FUNDAMENT - - VIS POUR FONDATION		14	5x120	
		DOOR HANDLE FITTINGS - TÜRGRIFF - SET DE GARNITURES DE SERRURE DE PORTE		2		
		HAMMER BLOCK - SCHLAGHOLZ - CALLE DE FRAPPE 40mm		1		
		SCREW FOR DOORSTEP - SCHRAUBEN FÜR SWELLE - - VIS DE FIXATION DU SEUIL DE PORTE		5	4.5x65	
		ZN NAIL FOR ROOF - ZN NÄGEL FÜR DACHBRETT - POINTE POUR TOIT		460	2x50	
		ZN NAIL FOR FLOOR - ZN NÄGEL FÜR FUSSBODENBRETT - - CLOUS POUR PLANCHER		308	2x50	
		ZN NAIL FOR ROOFING FELT FILLET - ZN NÄGEL FÜR DACHPAPPENLEISTE - - POINTE POUR BAGUETTE FIXATION FEUTRE BITUMEUX		24	2x40	
		BOLT FOR WINDOW HANDLE FITTINGS - BOLZEN FÜR FENSTERGRIFF BESCHLAG - BOULON POUR POIGNÉE D'OUVERTURE DE FENETRE		2		
		MALE BOLT HINGE FOR DOOR - TÜRRIEGEL - PARTIE MALE DE CHARNIERE DE PORTE		6		
		SCREW FOR GABLE MOULDING - SCHRAUBEN FÜR GIEBELLEISTE - - VIS DE FIXATION POUR PLANCHE DE RIVE		32	3.5x50	
		SCREW FOR ROOF EDGE REINFORCEMENT - SCHRAUBEN FÜR DACHRANDVERSTÄRKUNG - VIS POUR RENFORT DE BORD DE TOIT		24	4x40	
		GABLE SEGMENT-DECKBLATT - LOSANGE DE FINITION		2		

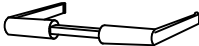
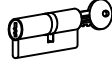
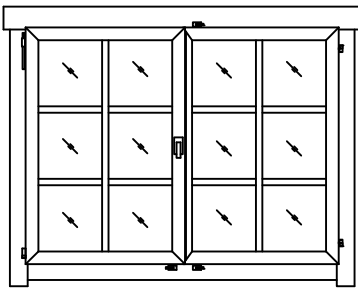
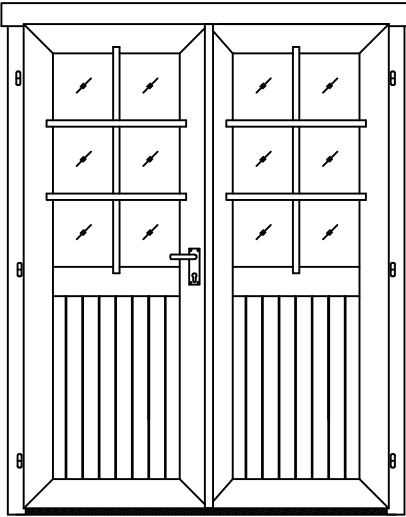
Pos	07.12.2012	Piecelist - Stücklist - Liste des composants Art.Nr. 406100	11/11	Q.	P. (mm)	L. (mm)
		NUT FOR STORM PROTECTION - SCHRAUBENMUTTER FÜR STURMLEISTE - - ÉCROU POUR LAME ANTI-TEMPETE		8		
		BOLT FOR STORM PROTECTION - BOLZEN FÜR STURMLEISTE - - VIS POUR LAME ANTI-TEMPETE		8		
		WASHER FOR STORM PROTECTION - DICHTSCHEIBE FÜR STURMLEISTE - - RONDELLE POUR LAME ANTI-TEMPETE		8		
		DOOR HANDLE FITTINGS - TÜRGRIF - GARNITURE DE POIGNÉE DE PORTE		2		
		CYLINDER - ZYLINDERSCHLOSS - CYLINDRE DE SERRURE		2		
		WINDOW - FENSTER - FENETRE 1290x990	TAK.1.106.SSV.b	1		
						
		DOOR - TÜR - PORTE 1494x1957	TUK.2.056.SVV.MMb	1		
						
		DOOR - TÜR - PORTE 835x1957	UL.2.100.IVV.MM	1		
		